

		b
140/190	227	266
140/200	237	266
144/190	227	270
144/200	237	270
160/190	227	286
160/200	237	286
164/190	227	290
164/200	237	290
180/190	227	306
180/200	237	306

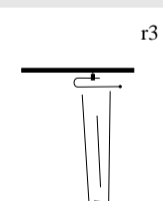

4

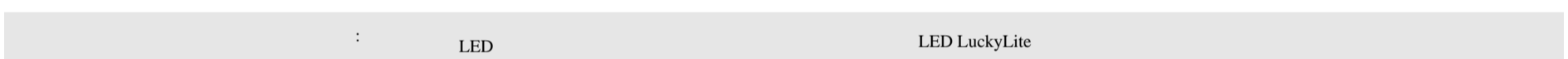
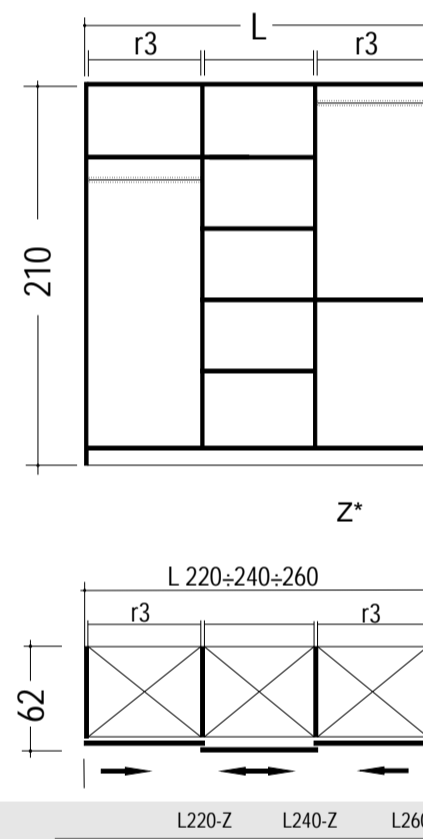
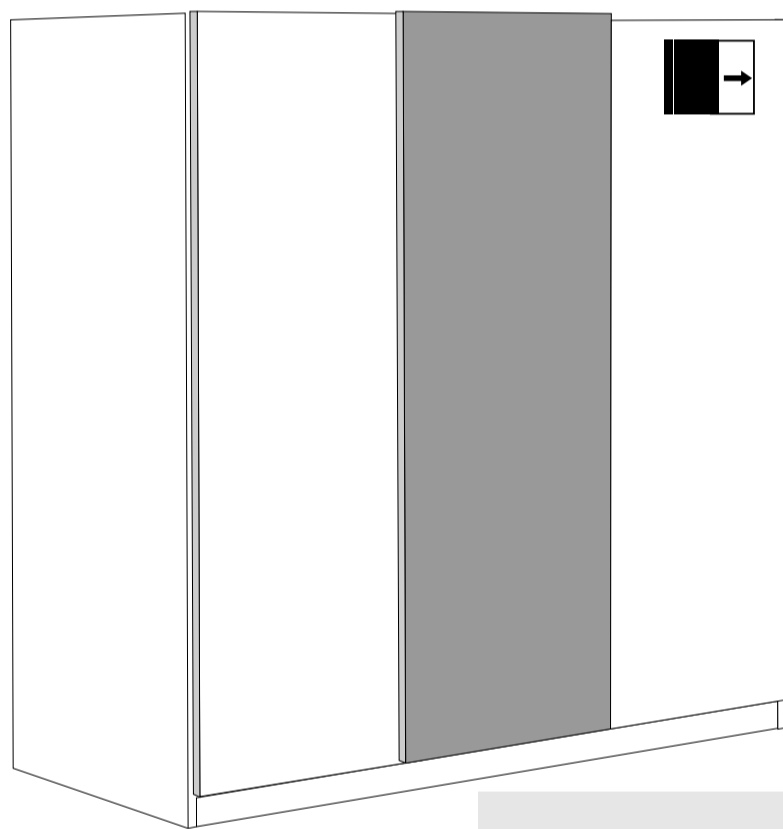
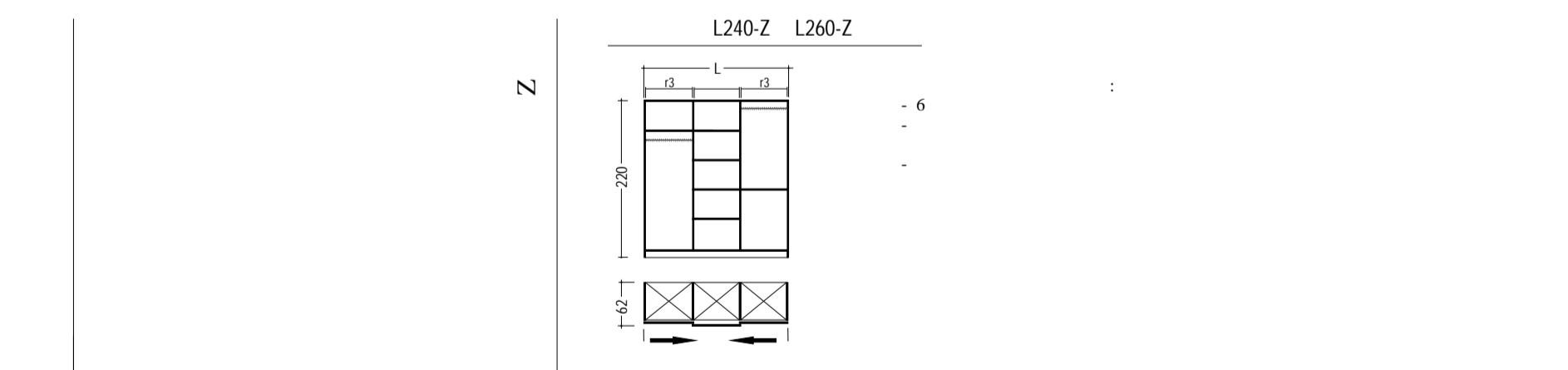

Z:
L220 Z
L240 Z
L260 Z

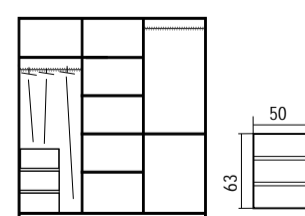
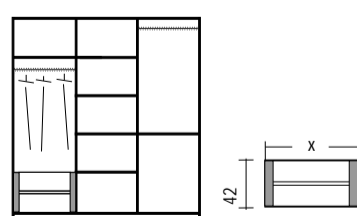

r3:

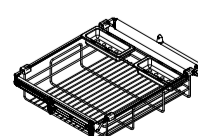
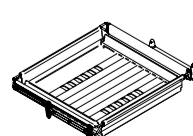

+